

MARK	DATE	ECN NO.	DESCRIPTION	REV.	DESIGN
△					

P1

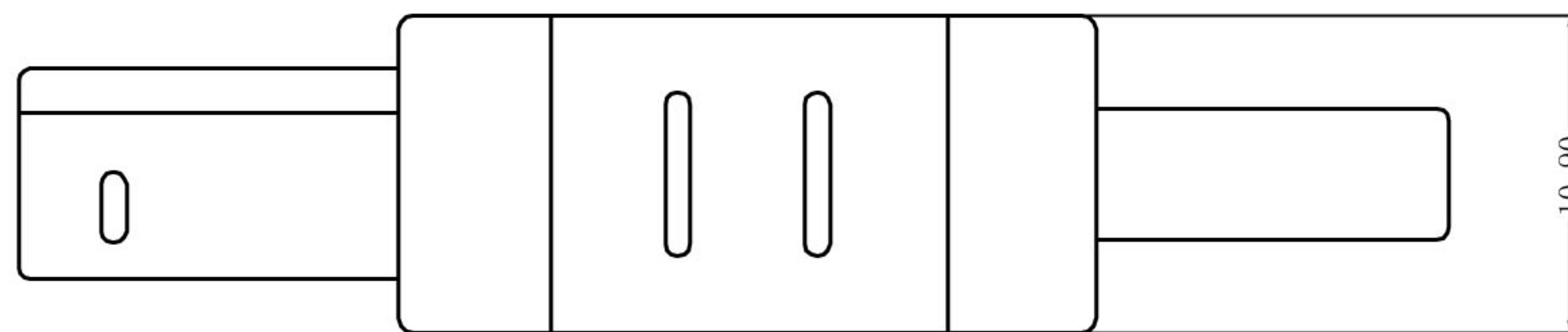
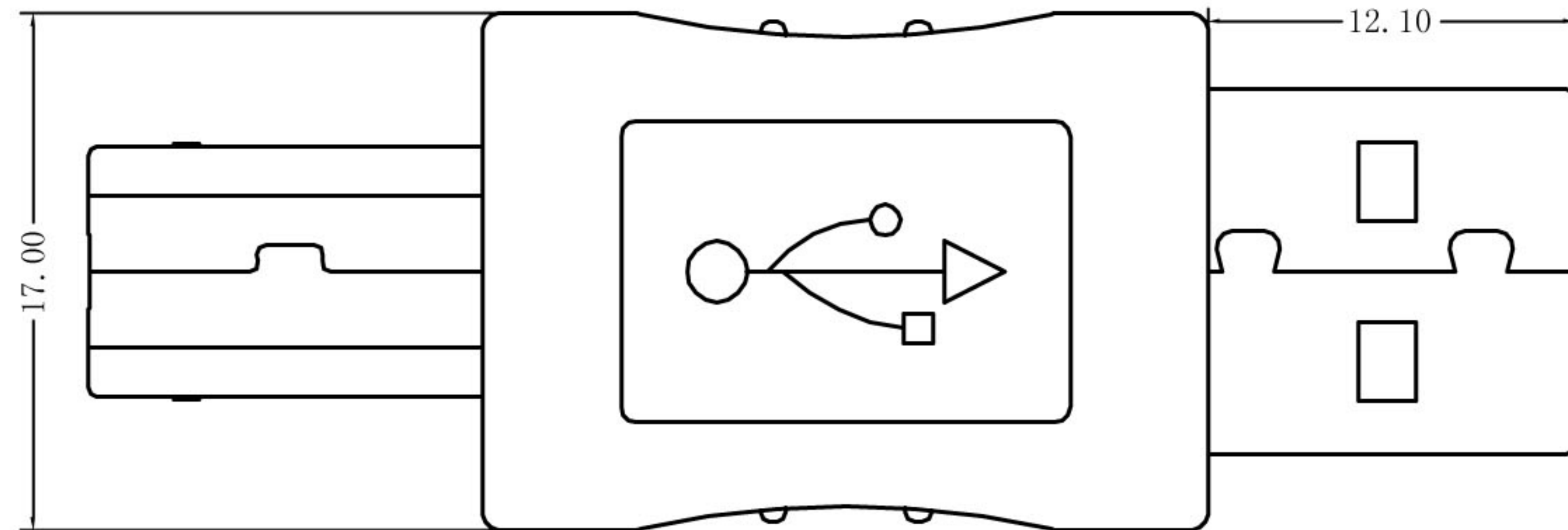
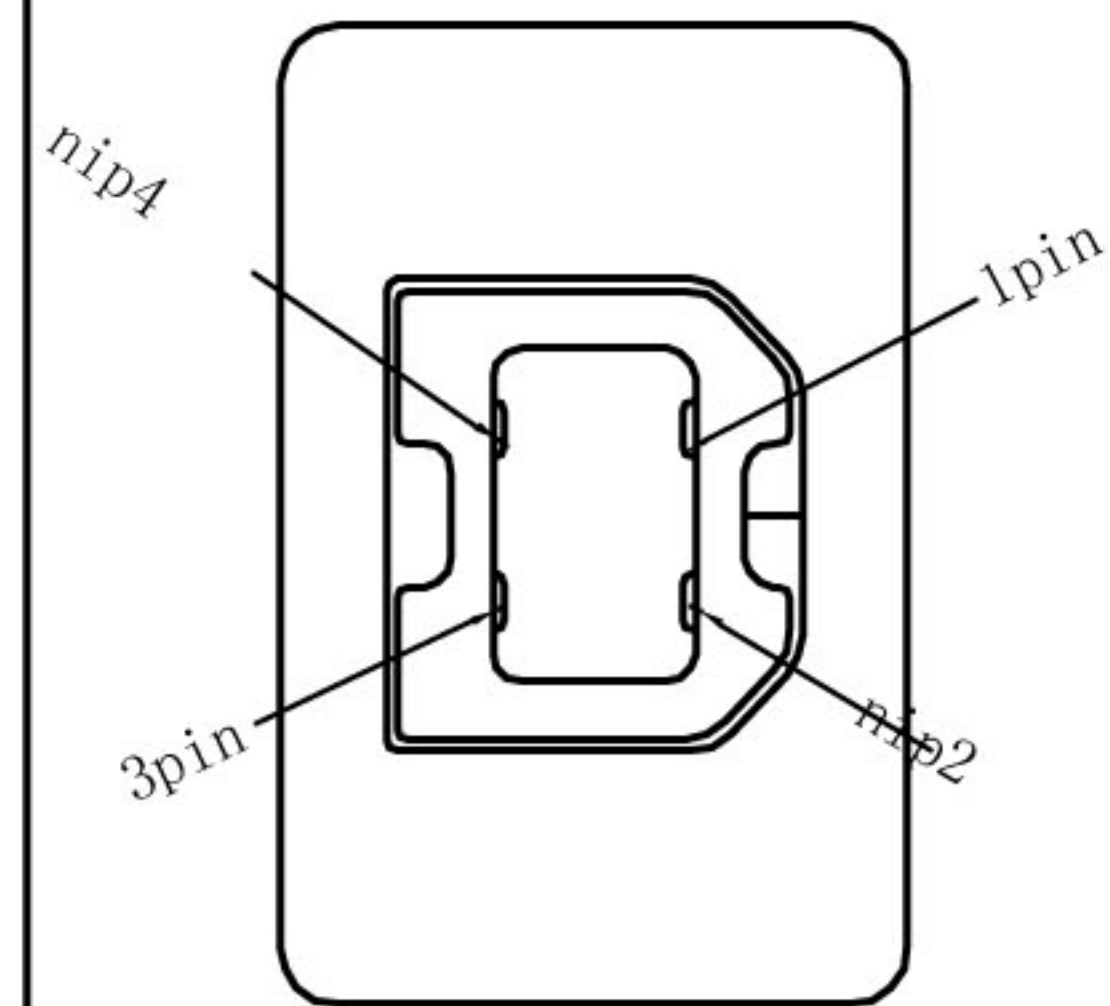
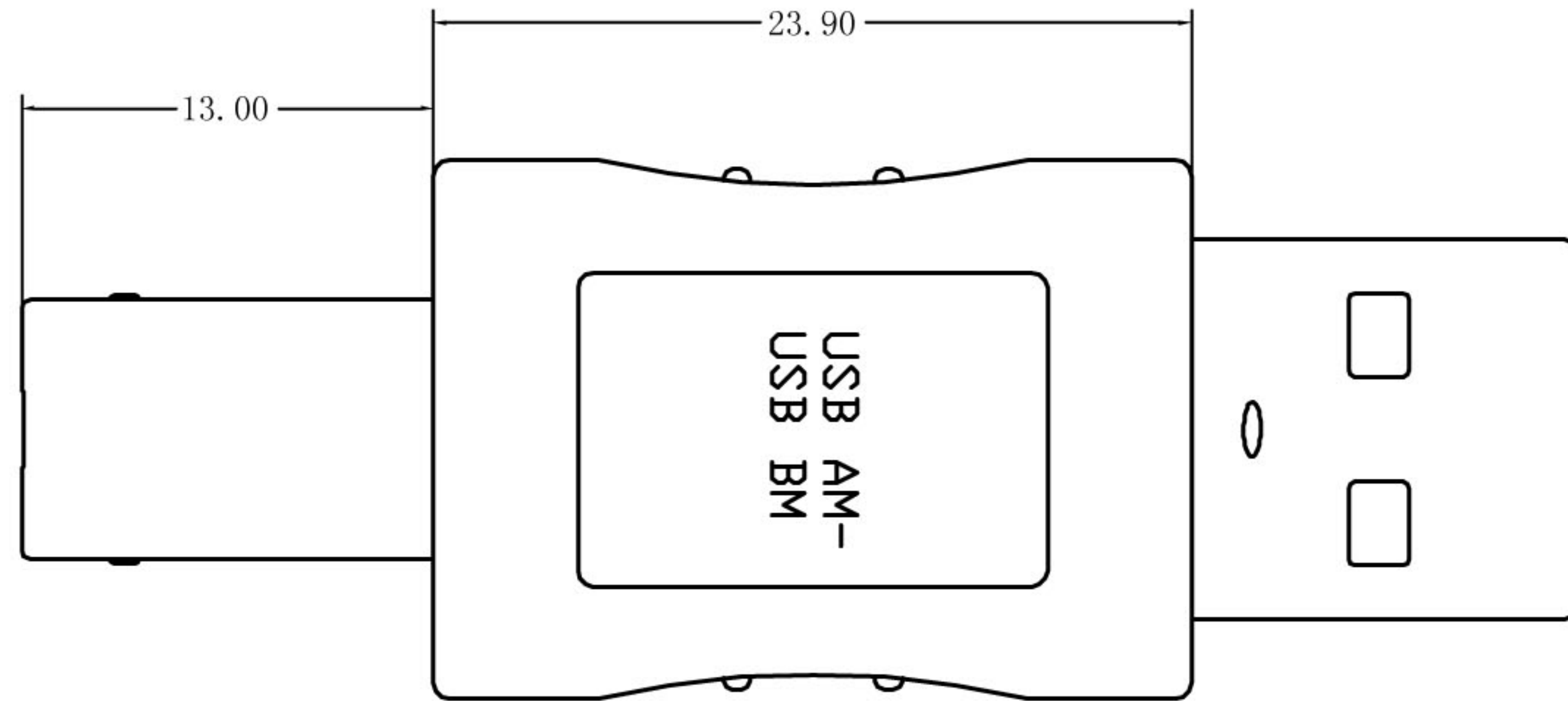

P2

规格:

1. 耐电压: 300V DC MIN
2. 接触阻抗: 5mΩ MAX
3. 绝缘电阻: 10MΩ MIN
4. 所用材质须符合RoHS要求
5. 100%短断路测试

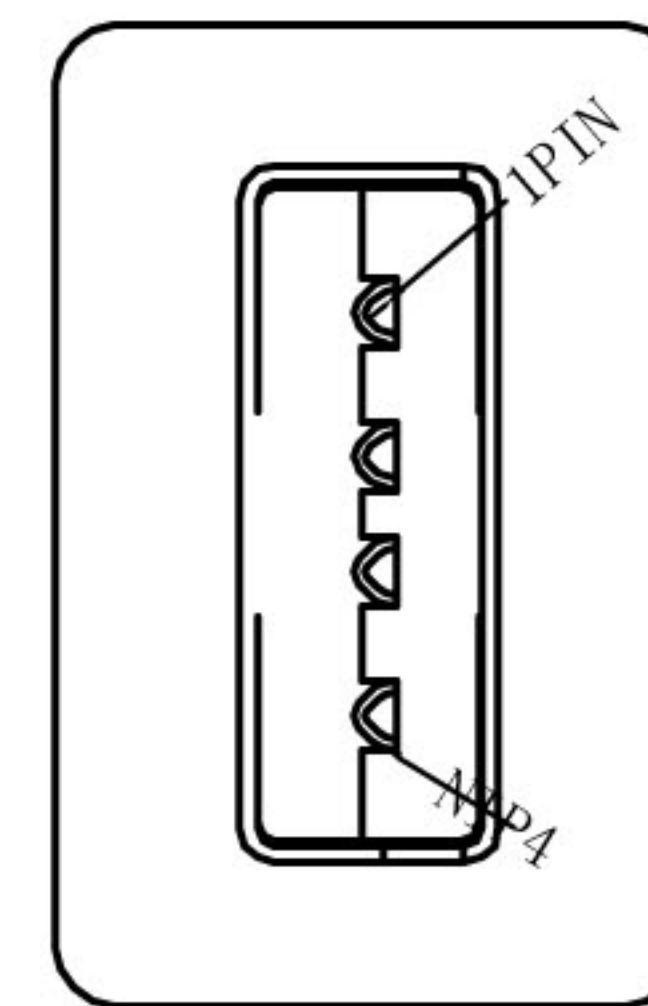

接线图



SHELL ————— SHELL

P1: USB 2.0 B male

P2: USB 2.0 A male

⑤ 电子线	5PCS	28AWG 7×0.12mm 芯线 L=21 地线 L=22mm
④ 外膜	g	45P黑色PVC
③ 内膜	g	高密度PE
② USB 2.0 B/M	1PCS	端子: C2680 半金锡G/F; 外壳: C2680/SPCC, 全金/镍; 胶芯: PBT
① USB 2.0 A/M	1PCS	端子: C2680 半金锡G/F; 外壳: C2680/SPCC, 全金/镍; 胶芯: PBT
零件	数量	材料规格

UNLESS OTHERWISE SPECIFIED TOLERANCE			
ANG	TOL	DIM	TOL
.X	±3.0°	.X	±0.10
.XX	±2.0°	.XX	±0.05
.XXX	±1.0°	.XXX	±0.03

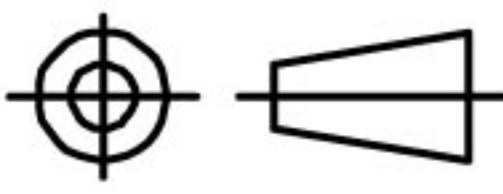
 an INFINIT® brand									
DRAW NO.		DATE	TITLE	USB 2.0 A Male to B Male Adapter					
DESIGN	CLH	07/16'10	PART NO.	3507					
VERIFIED				UNITS	SCALE	PAGE	REV		
APPROVED				mm	1:1	1/1	1		